

Führungszahnstangen für fortlaufende Montage mit geschl. Zahnflanken, geradzahnt, Rücken - und Seitenflächen geschliffen

Racks for Guideways, for Continuous Mounting with Ground Teeth, Straight Teeth, Ground Rear and Side Surface

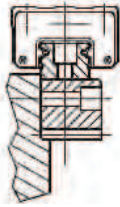

Ausführung | execution **180°**

Material | material

1.0503
[C45]

induktiv gehärtet | induction hardened

50-55 HRC

geradzahnt | straight teeth

Eingriffswinkel | pressure angle

20°

Verzahnungsqualität | toothing quality

6 h23

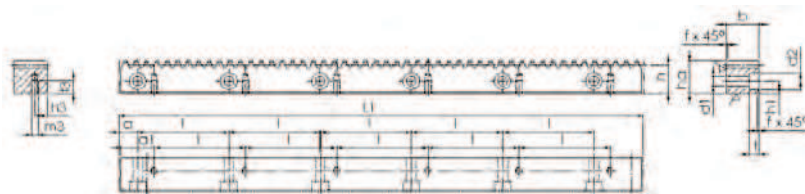

Modul Module	Teilung Pitch	theor. L_1	z^{**}	b	h_a	h	f	a	l	Anz. Bohr. No. of holes	h_1	d_1	d_2	t	a_1	m_3	h_3	t_3	[kg]	Bestell Nr. Part No.
1,591	5,0	960	192	19	19,50	17,91	1	10	60	16	7,5	5,8	10	6	30	M4	7,5	8,0	2,7	144-816-110
1,591	5,0	960	192	24	24,50	22,91	1	10	60	16	10,0	7,0	11	7	30	M5	10,0	11,0	4,2	144-816-210
3,183	10,0	960	96	29	29,75	26,57	2	10	60	16	11,5	10,0	15	9	30	M6	11,5	13,5	5,6	144-831-210

Ausführung | execution **90°**

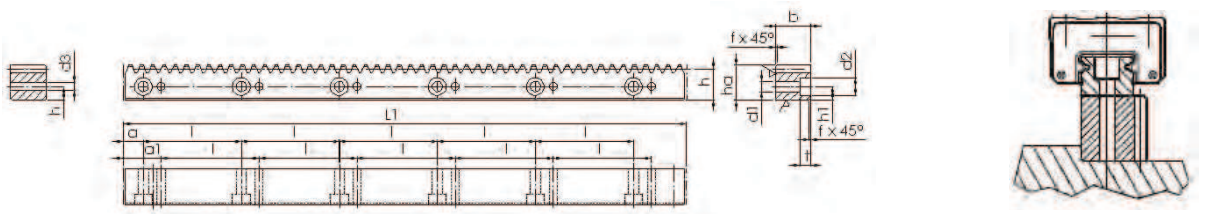

Modul Module	Teilung Pitch	theor. L_1	z^{**}	b	h_a	h	f	a	l	Anz. Bohr. No. of holes	h_1	d_1	d_2	t	a_1	d_3	[kg]	Bestell Nr. Part No.	
1,591	5,0	960	192	19	19,50	17,91	1	10	60	16	7,5	4,5	7,5	5,3	30	4,5		2,7	144-916-110
1,591	5,0	960	192	24	24,50	22,91	1	10	60	16	10,0	6,0	9,5	8,5	30	6,0		4,2	144-916-210
3,183	10,0	960	96	29	29,75	26,57	2	10	60	16	11,5	7,0	11,0	9,0	30	7,0		5,6	144-931-210

z^{**} ... Zähnezahl | number of teeth

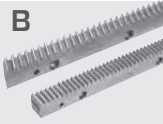

Führungszahnstangen für fortlaufende Montage mit geschl. Zahnflanken, schrägverzahnt, Rücken - und Seitenflächen geschliffen

Racks for Guideways, for Continuous Mounting with Ground Teeth, Helical Teeth, Ground Rear and Side Surface

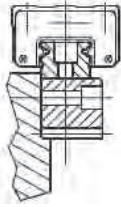

Ausführung | execution **180°** Material | material **1.0503 [C45]**
 induktiv gehärtet | induction hardened **50-55 HRC**
 Schrägungswinkel | helix angle **19°31'42" rechtssteigend**
 19°31'42" right hand
 Eingriffswinkel | pressure angle **20°**
 Verzahnungsqualität | tooth quality **6 h23**

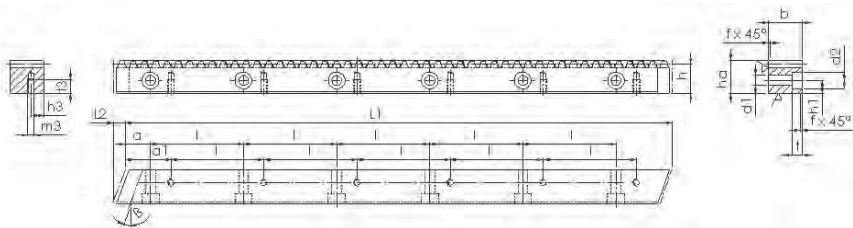

Modul Module	Teilung Pitch	theor. L ₁	z**	b	h _a	h	f	a	l	Anz. Bohr. No. of holes	h ₁	d ₁	d ₂	t	a ₁	m ₃	h ₃	t ₃	[kg]	Bestell Nr. Part No.
2	960	6,70	144	19	19,50	17,50	1	10	60	16	7,5	5,8	10	6	30	M4	7,5	8,0	2,7	143-820-110
2	960	8,50	144	24	24,50	22,50	1	10	60	16	10,0	7,0	11	7	30	M5	10,0	11,0	4,2	143-820-210
3	960	10,30	96	29	29,75	26,75	2	10	60	16	11,5	10,0	15	9	30	M6	11,5	13,5	5,6	143-830-210
4	960	13,83	72	39	39,75	35,75	2	20	80	12	14,0	12,0	18	12	40	M8	14,0	16,0	10,5	143-840-310
4	960	13,83	72	39	48,75	44,75	2	20	80	12	17,0	12,0	18	12	40	M8	17,0	16,0	13,0	143-840-410
4	840	17,38	63	49	58,00	54,00	2	30	105	8	22,5	14,0	20	13	60	M12	22,5	25,0	17,3	143-840-510

Ausführung | execution **90°**

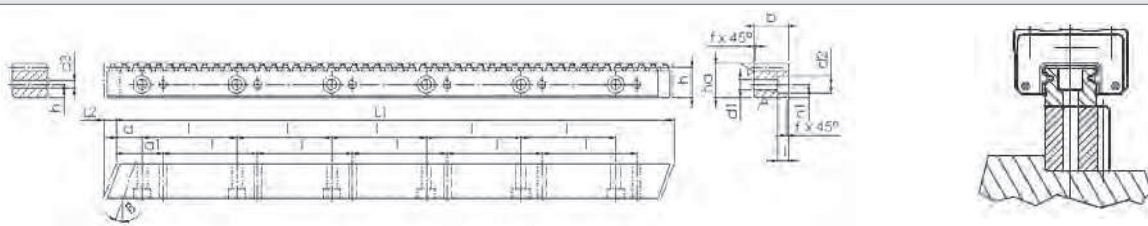

Modul Module	Teilung Pitch	theor. L ₁	z**	b	h _a	h	f	a	l	Anz. Bohr. No. of holes	h ₁	d ₁	d ₂	t	a ₁	d ₃	[kg]	Bestell Nr. Part No.	
2	960	6,70	144	19	19,50	17,50	1	10	60	16	7,5	4,5	7,5	5,3	30	4,5		2,7	143-920-110
2	480	6,70	72	19	19,50	17,50	1	10	60	8	7,5	4,5	7,5	5,3	30	4,5		1,3	143-920-105
2	960	8,50	144	24	24,50	22,50	1	10	60	16	10,0	6,0	9,5	8,5	30	6,0		4,2	143-920-210
2	480	8,50	72	24	24,50	22,50	1	10	60	8	10,0	6,0	9,5	8,5	30	6,0		2,1	143-920-205
3	960	10,30	96	29	29,75	26,75	2	10	60	16	11,5	7,0	11,0	9,0	30	7,0		5,6	143-930-210
3	480	10,30	48	29	29,75	26,75	2	10	60	8	11,5	7,0	11,0	9,0	30	7,0		2,8	143-930-205
4	960	13,83	72	39	39,75	35,75	2	20	80	12	14,0	10,0	15,0	9,0	40	10,0		10,5	143-940-310
4	480	13,83	36	39	39,75	35,75	2	20	80	6	14,0	10,0	15,0	9,0	40	10,0		5,2	143-940-305
4	960	13,83	72	39	48,75	44,75	2	20	80	12	17,0	10,0	15,0	9,0	40	10,0		13,0	143-940-410
4	480	13,83	36	39	48,75	44,75	2	20	80	6	17,0	10,0	15,0	9,0	40	10,0		6,5	143-940-405
4	840	17,38	63	49	58,00	54,00	2	30	105	8	22,5	14,0	20,0	13,0	60	14,0		17,3	143-940-510

z**... Zähnezahl | number of teeth

Führungszahnstangen für fortlaufende Montage - gefräst, geradzahnt

Racks for Guideways, for Continuous Mounting - with Milled Teeth, Straight Teeth

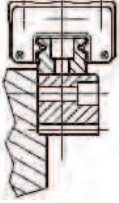

Ausführung | execution **180°**

Material | material **1.0503 [C45]**

weich | soft

geradzahnt | straight teeth

Eingriffswinkel | pressure angle **20°**

Verzahnungsqualität | toothing quality **9 h27**

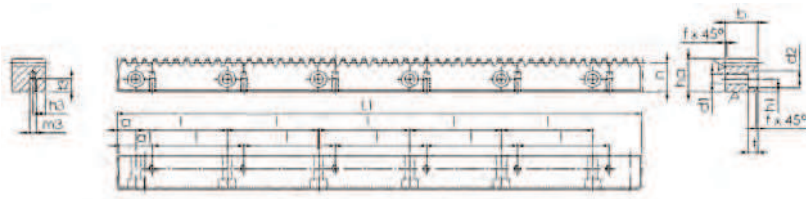

Modul Module	Teilung Pitch	theor. L ₁	z ^{**}	b	h _a	h	f	a	l	Anz. Bohr. No. of holes	h ₁	d ₁	d ₂	t	a ₁	m ₃	h ₃	t ₃	[kg]	Bestell Nr. Part No.
1,591	5,0	1920	384	20	19,50	17,91	1	10	60	32	7,5	5,8	10	6	30	M4	7,5	8,0	5,4	146-816-120
1,591	5,0	1920	384	25	24,50	22,91	1	10	60	32	10,0	7,0	11	7	30	M5	10,0	11,0	8,4	146-816-220
3,183	10,0	1920	192	30	29,75	26,57	2	10	60	32	11,5	10,0	15	9	30	M6	11,5	13,5	11,2	146-831-220

Ausführung | execution **90°**

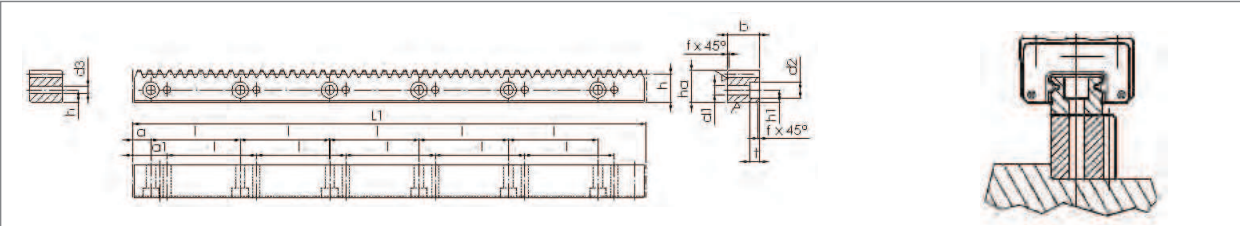

Modul Module	Teilung Pitch	theor. L ₁	z ^{**}	b	h _a	h	f	a	l	Anz. Bohr. No. of holes	h ₁	d ₁	d ₂	t	a ₁	d ₃	[kg]	Bestell Nr. Part No.
1,591	5,0	1920	384	20	19,50	17,91	1	10	60	32	7,5	4,5	7,5	5,3	30	4,5	5,4	146-916-120
1,591	5,0	1920	384	25	24,50	22,91	1	10	60	32	10,0	6,0	9,5	8,5	30	6,0	8,4	146-916-220
3,183	10,0	1920	192	30	29,75	26,57	2	10	60	32	11,5	7,0	11,0	9,0	30	7,0	11,2	146-931-220

z^{**}... Zähnezahl | number of teeth



Führungszahnstangen für fortlaufende Montage - gefräst, schrägverzahnt Racks for Guideways, for Continuous Mounting - with Milled Teeth, Helical Teeth



Ausführung | execution **180°**

Material | material **1.0503 [C45]**

weich | soft

Schrägungswinkel | helix angle **19°31'42" rechtssteigend**
19°31'42" right hand

Eingriffswinkel | pressure angle **20°**

Verzahnungsqualität | toothing quality **9 h27**

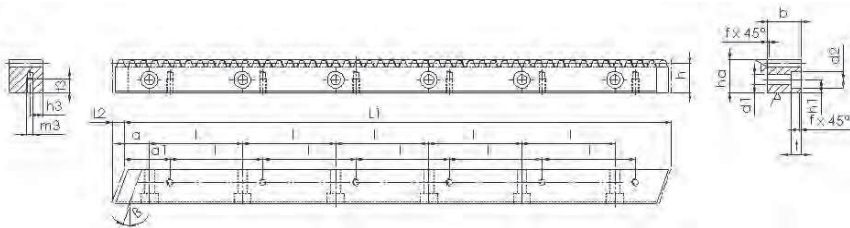

Modul Module	theor. L ₁	L ₂	z**	b	h _a	h	f	a	l	Anz. Bohr. No. of holes	h ₁	d ₁	d ₂	t	a ₁	m ₃	h ₃	t ₃	[kg]	Bestell Nr. Part No.
2	1920	7,1	288	20	19,50	17,50	1	10	60	32	7,5	5,8	10	6	30	M4	7,5	8,0	5,4	145-820-120
2	1920	8,9	288	25	24,50	22,50	1	10	60	32	10,0	7,0	11	7	30	M5	10,0	11,0	8,4	145-820-220
3	1920	10,6	192	30	29,75	26,75	2	10	60	32	11,5	10,0	15	9	30	M6	11,5	13,5	11,2	145-830-220
4	1920	14,2	144	40	39,75	35,75	2	20	80	24	14,0	12,0	18	12	40	M8	14,0	16,0	21,5	145-840-320

Ausführung | execution **90°**

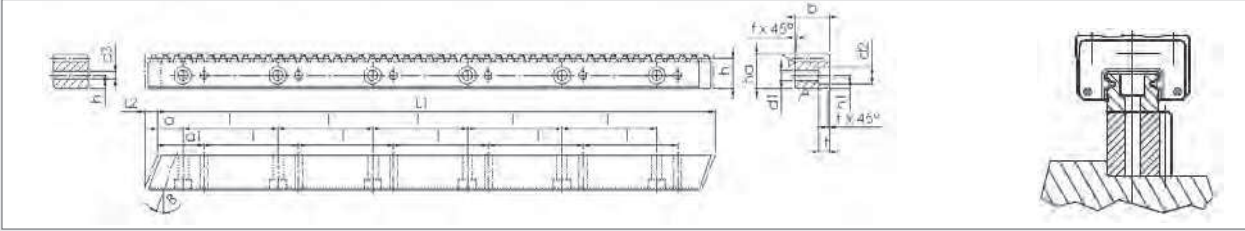

Modul Module	theor. L ₁	L ₂	z**	b	h _a	h	f	a	l	Anz. Bohr. No. of holes	h ₁	d ₁	d ₂	t	a ₁	d ₃	[kg]	Bestell Nr. Part No.	
2	1920	7,1	288	20	19,50	17,50	1	10	60	32	7,5	4,5	7,5	5,3	30	4,5		5,4	145-920-120
2	1920	8,9	288	25	24,50	22,50	1	10	60	32	10,0	6,0	9,5	8,5	30	6,0		8,4	145-920-220
3	1920	10,6	192	30	29,75	26,75	2	10	60	32	11,5	7,0	11,0	9,0	30	7,0		11,2	145-930-220
4	1920	14,2	144	40	39,75	35,75	2	20	80	24	14,0	10,0	15,0	9,0	40	10,0		21,5	145-940-320

z**... Zähnezahl | number of teeth

Führungszahnstangen für Linearführungen der Baureihe Z ⁽¹⁾ Racks for Guideways for Linear Guideways Z Series ⁽¹⁾



Aufbau der 180°-Zahnstangenführung
Design of the 180° rack guideway

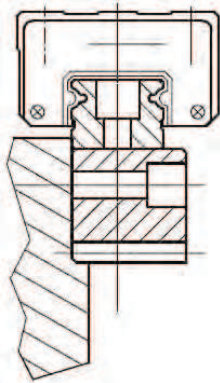

Aufbau der 90°-Zahnstangenführung
Design of the 90° rack guideway

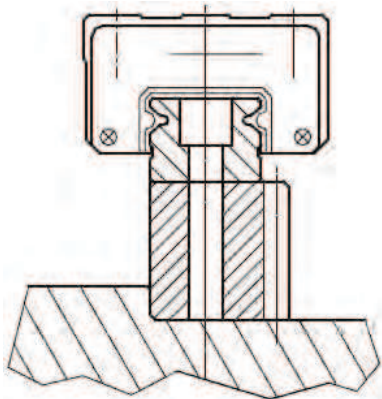

[1] Alle Informationen zur Baureihe Z entnehmen Sie bitte unserem Katalogkapitel „Lineartechnik“. Auf den Seiten R 5 & R 6 finden Sie allgemeine Hinweise zum Lieferprogramm, auf den Seiten R 7 - R 10 die geometrischen Abmessungen.

[1] For more information about our Z series, please see catalogue chapter „Linear Drives“. General notes about our product range you'll find on the pages R 5 & R 6, for geometric dimensions please see the pages R 7 - R 10.